

**BREATHTAKING
Design Strategy**

2008.08.04
ARNELL GROUP

WORK IN PROGRESS 2008.08.04

A. BREAKING THE CODE FOR INNOVATION
From Convention to Innovation

BREATH TAKING

Trajectory of Innovation

A. How do we move from convention to innovation?



B. By investing in our history and brand ethos we can create a new trajectory forward.

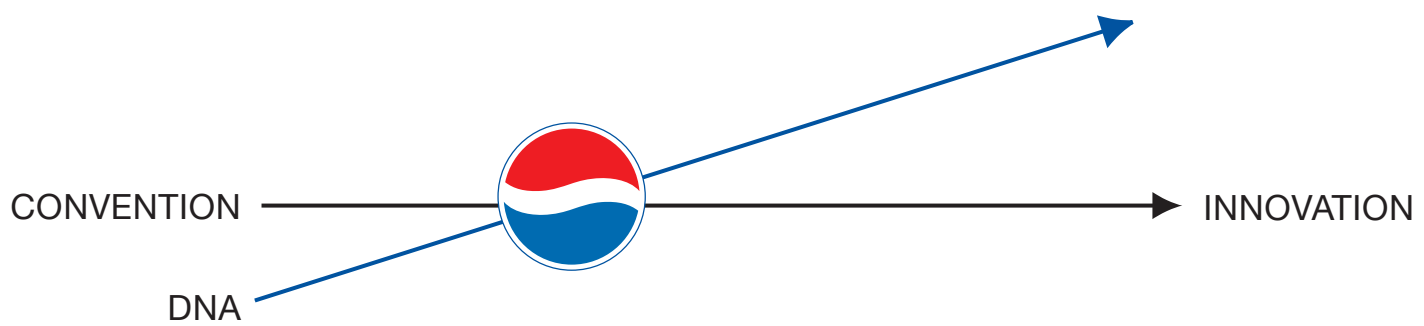

C. The investment in our DNA leads to breakthrough innovation and allows us to move out of the traditional linear system and into the future.

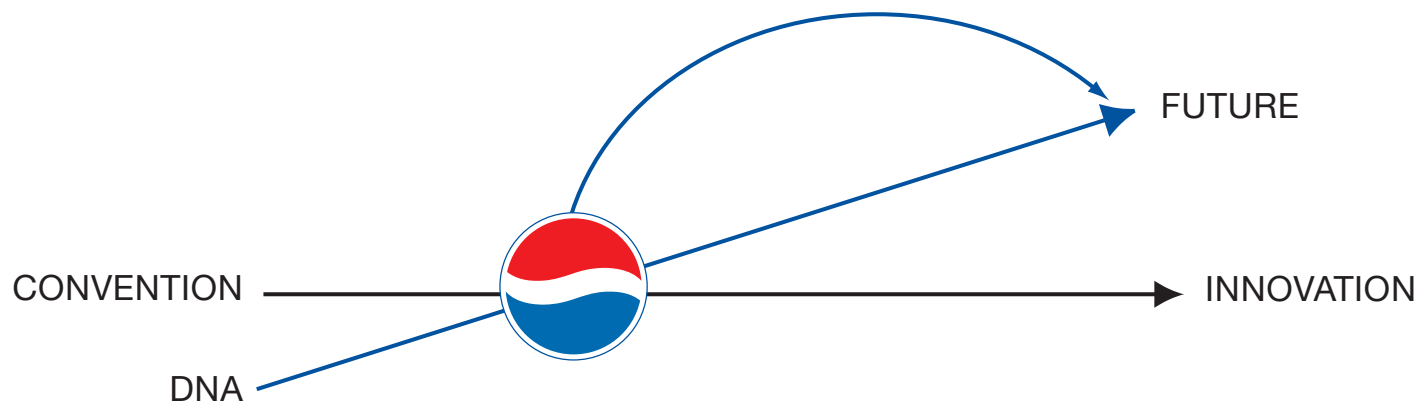

D. Continued investment provides us with a clear resource for reinvention.

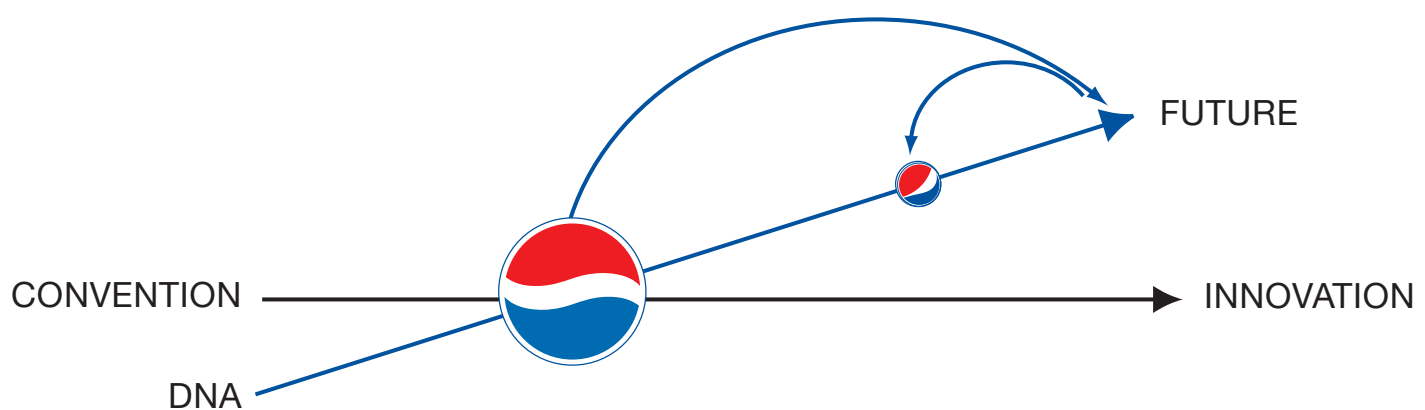

B. THE ORIGINS OF CREATIVE ENDEAVORS
Universal Design Principles and PepsiCo's Brand Heritage

BREATH TAKING

Brand Heritage and the Aesthetics of Simplicity

The Pepsi ethos has evolved over time. The vocabulary of truth and simplicity is a reoccurring phenomena in the brand's history. It communicates the brand in a timeless manner and with an expression of clarity. Pepsi BREATH TAKING builds on this knowledge. True innovation always begins by investigating the historic path. Going back-to-the-roots moves the brand forward as it changes the trajectory of the future.

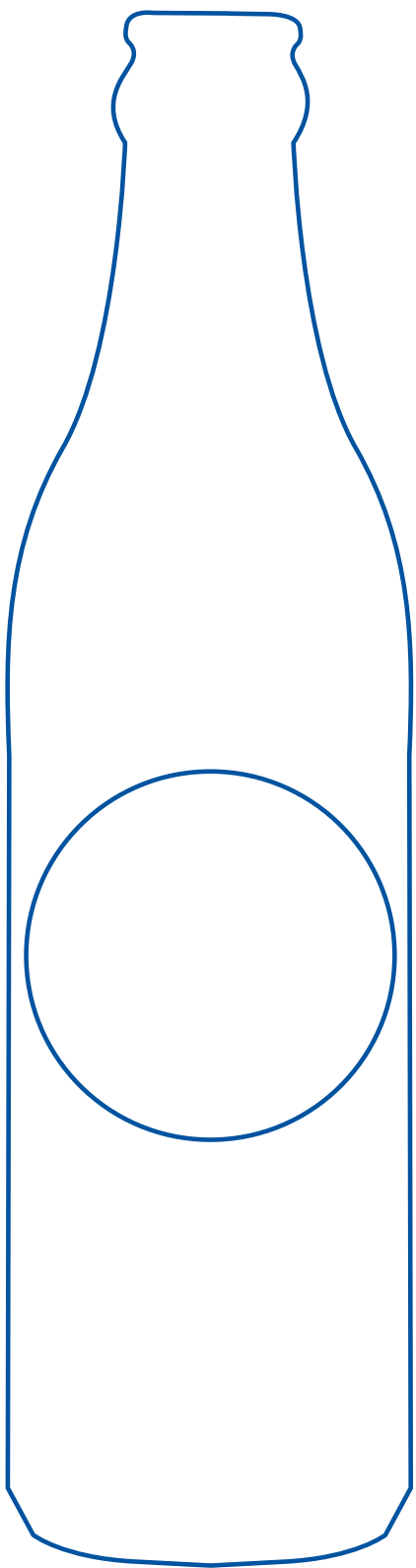

1910

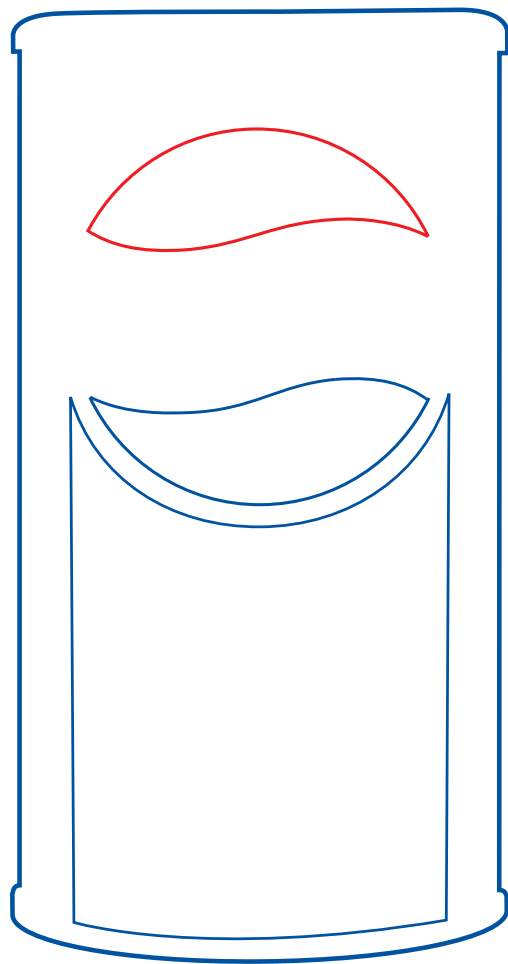

1970



2009

BREATH TAKING

Universal Design Principles

BREATH TAKING is a strategy based on the evolution of 5000+ years of shared ideas in design philosophy creating an authentic Constitution of Design. This chart documents the origin and evolution of intellectual property.

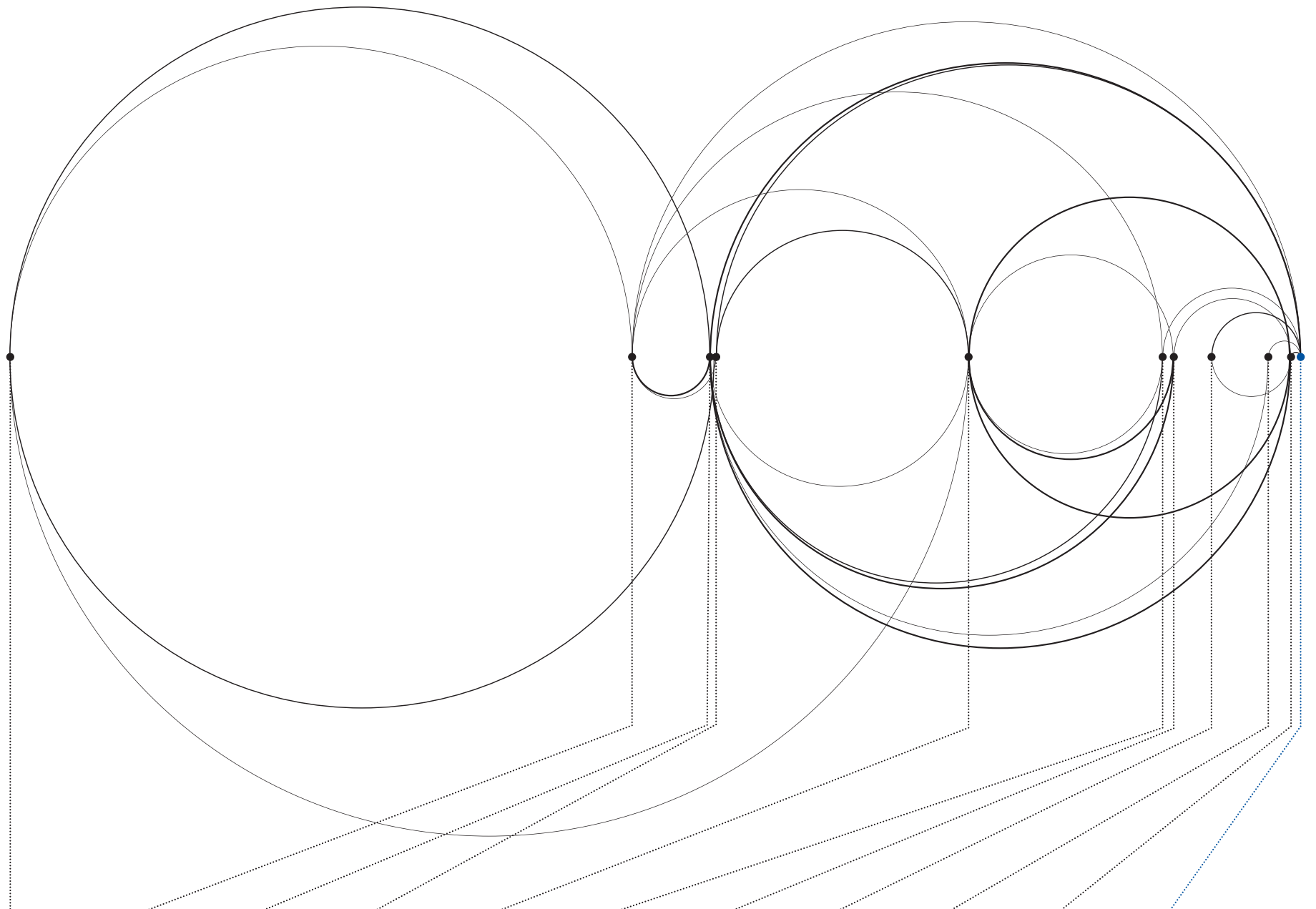

- | | | | | | | | | | | |
|---|--|--|--|---|--|---|--|--|--|----------------------------|
| 3000 BC
Vāstu Śāstra: | 600 BC
Musica Mundana: | 300 BC
Golden Ratio: | 278 BC
Feng Shui: | 70 BC
Vitruvian Principle: | 1452
The Art of Building: | 1455
Vitruvian Renaissance: | 1637
La Géométrie: | 1858
Möbius Strip: | 1948
The Modulor: | 2009
Pepsi: |
| Hindu Tradition of numerical harmony as spatial organizer | Pythagoras creates spatial hierarchies from musical scales | Euclid explores the mathematics and proportion of nature | Ancient Chinese art of placement and spatial arrangement | In "De Architectura" he demands: strong, useful, beautiful. | Alberti draws on the relation of numbers and areas | Rediscovery of the Vitruvian principles and their publication | Descartes develops the cartesian coordinate system | Möbius creates a surface with only one side and edge | Le Corbusier draws algebraic relations in the human body | Pepsi introduces Breathing |

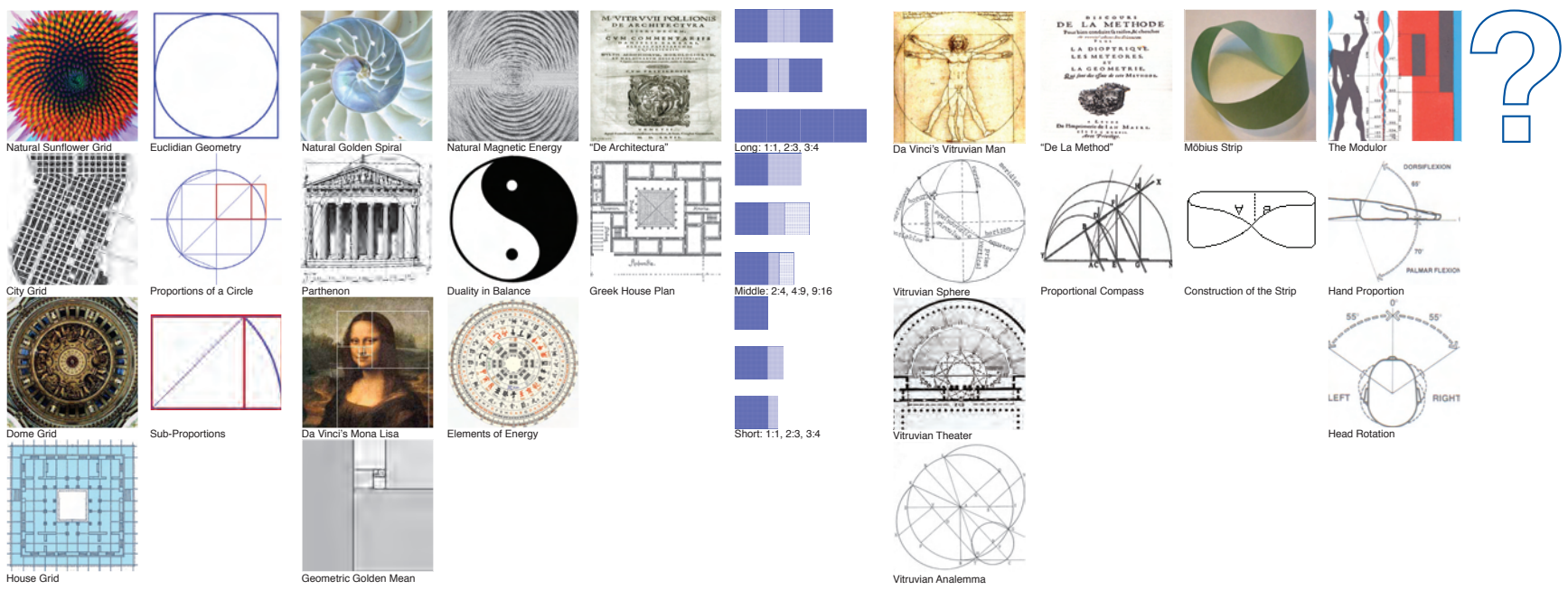

BREATHTAKING

Iconic Geometry

Derived from PepsiCo's rich packaging legacy and inspired by some of its earliest forms and proportions, BREATHTAKING revitalizes the essence of PepsiCo in creating an iconic shape for the brand.

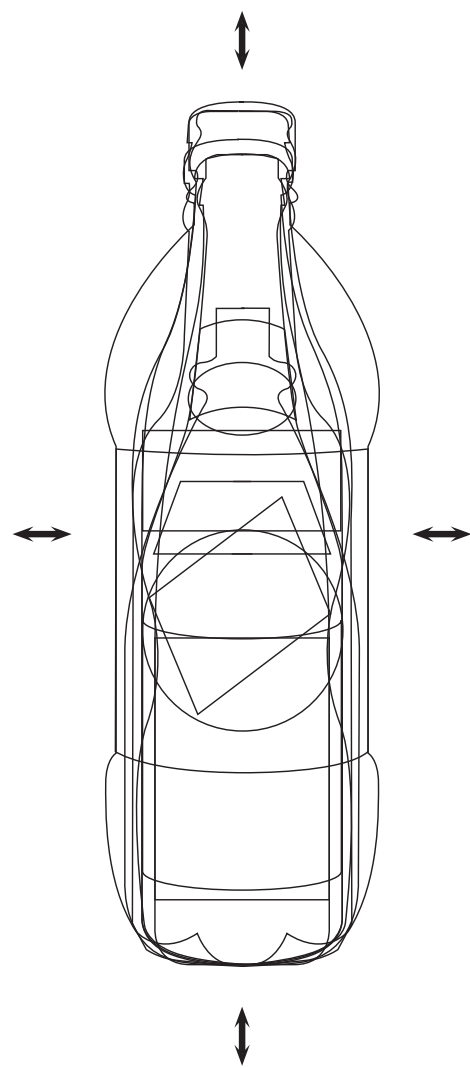
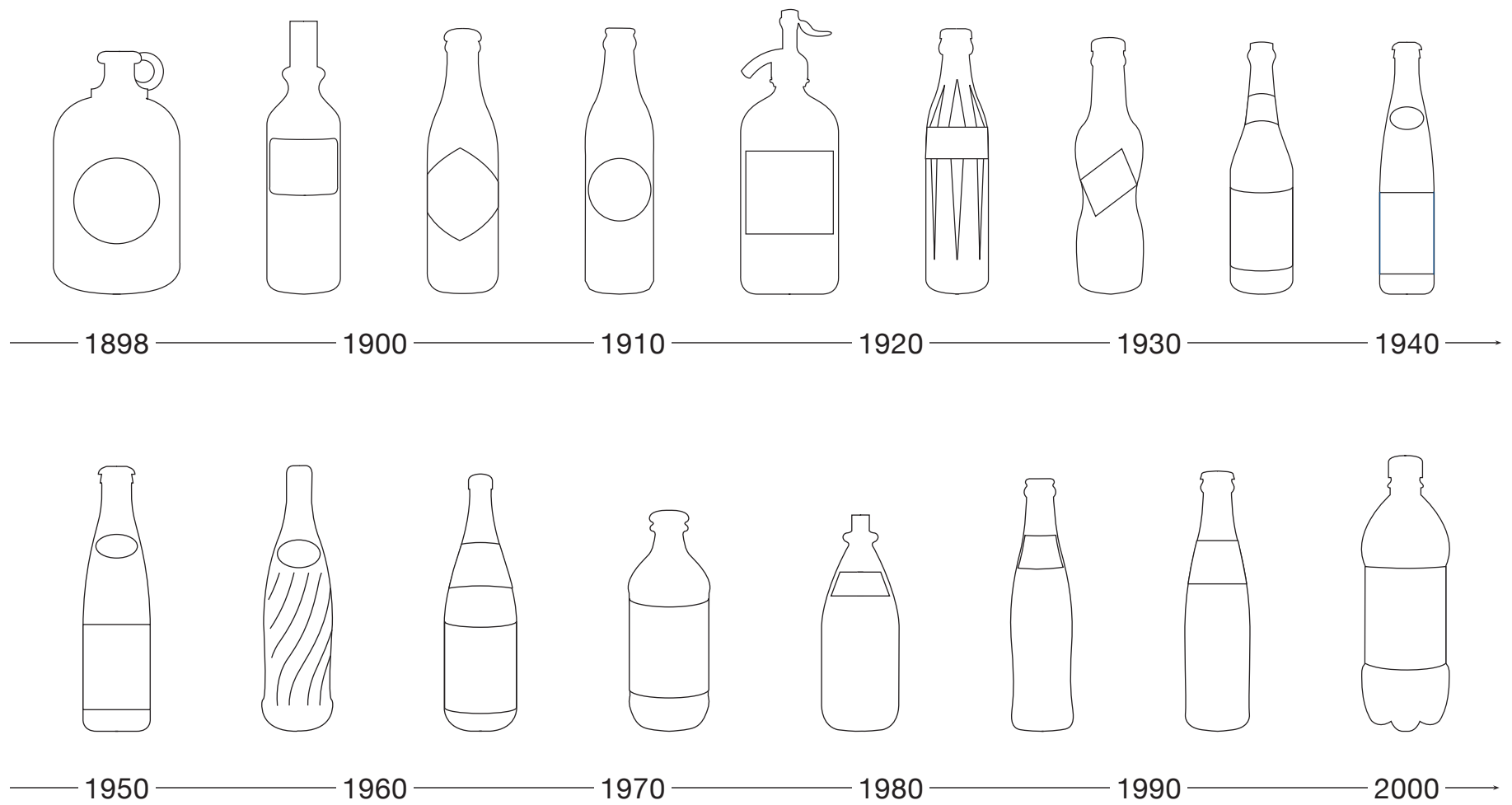

1898-2009
Retain the best of PepsiCo's history and shape the next PepsiCo bottle into an icon for the brand.

BREATH TAKING

Tracing the Pepsi DNA - 1898

1896 Pepsi Geometries: Perimeter Oscillations

The Pepsi DNA finds its origin in the dynamic of perimeter oscillations. This new identity manifests itself in an authentic geometry that is to become proprietary to the Pepsi culture.

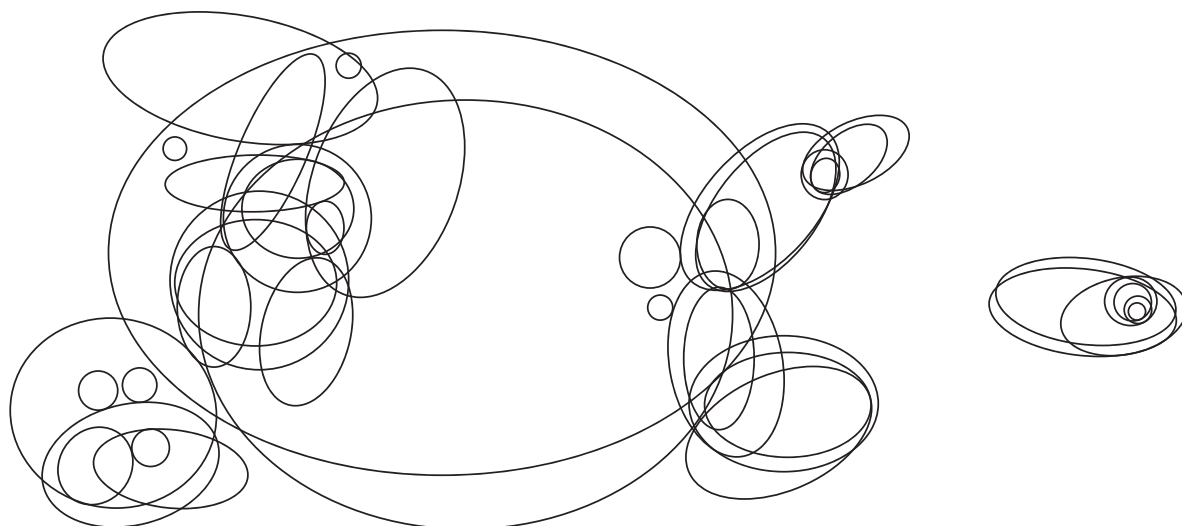
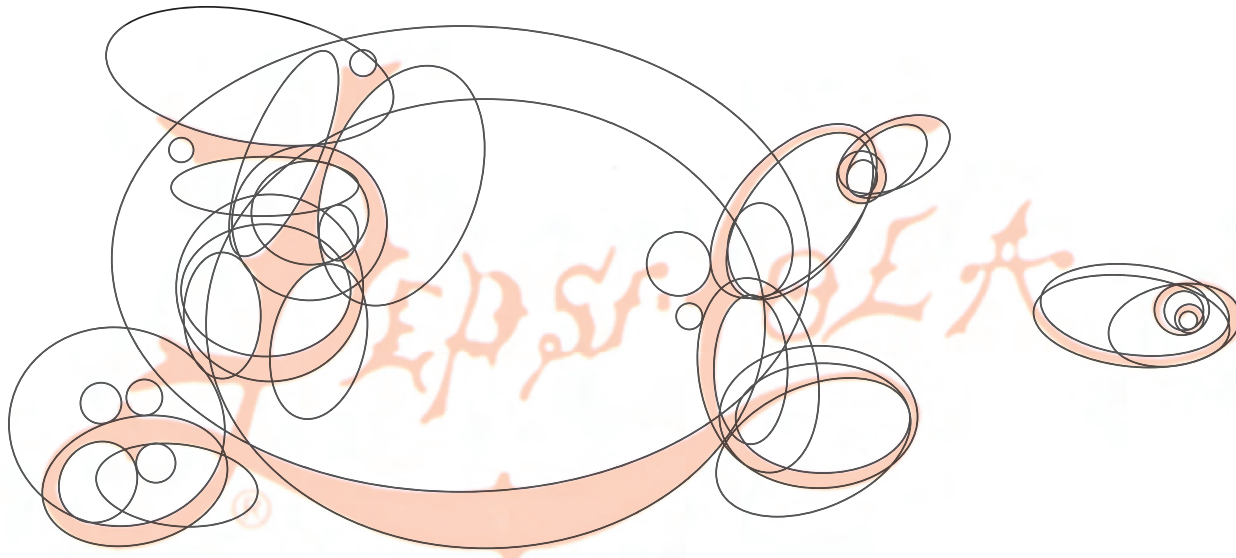

BREATHTAKING

Tracing the Pepsi DNA - 1905

1905 Pepsi Geometries: Perimeter Oscillations

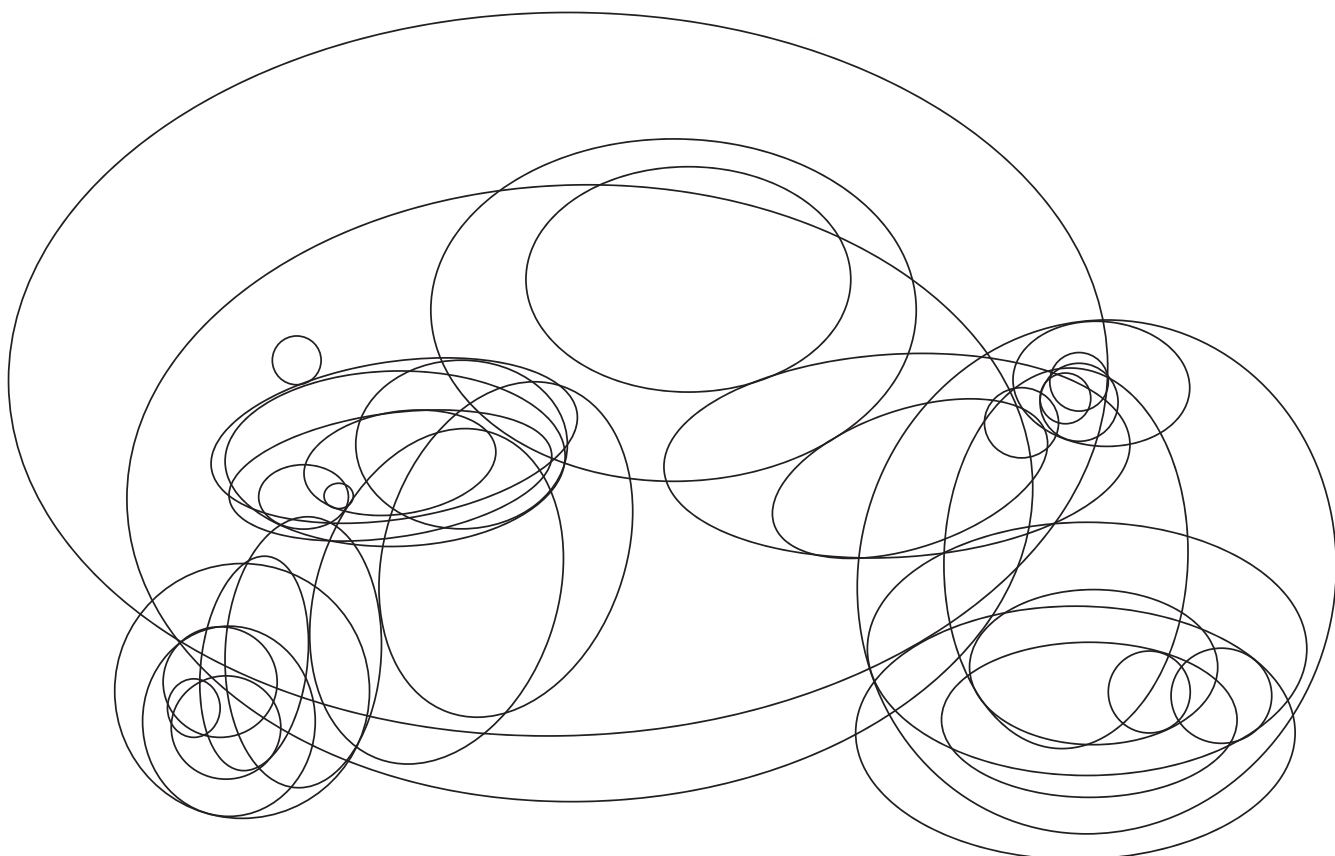
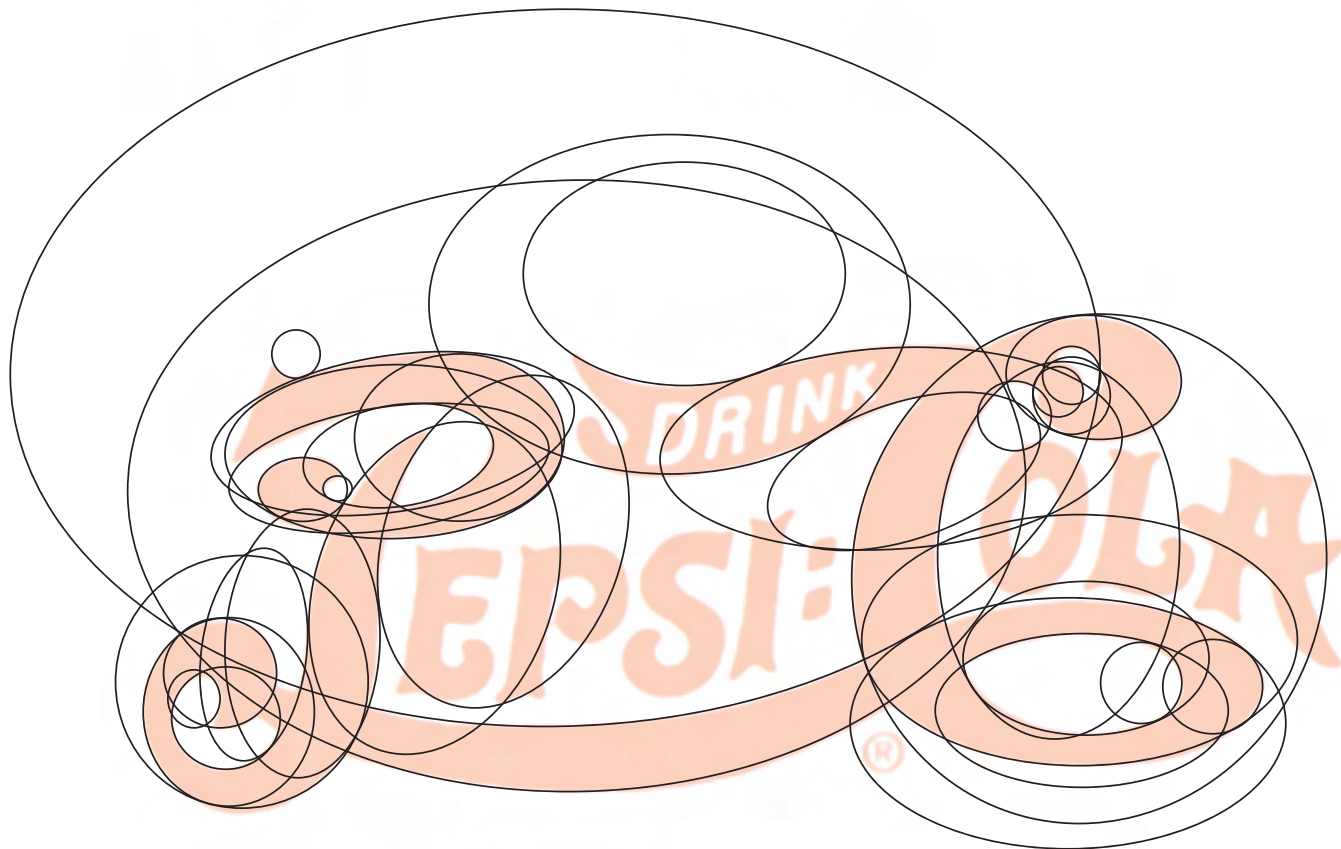

BREATHTAKING

Tracing the Pepsi DNA - 1906

1906 Pepsi Geometries: Perimeter Oscillations

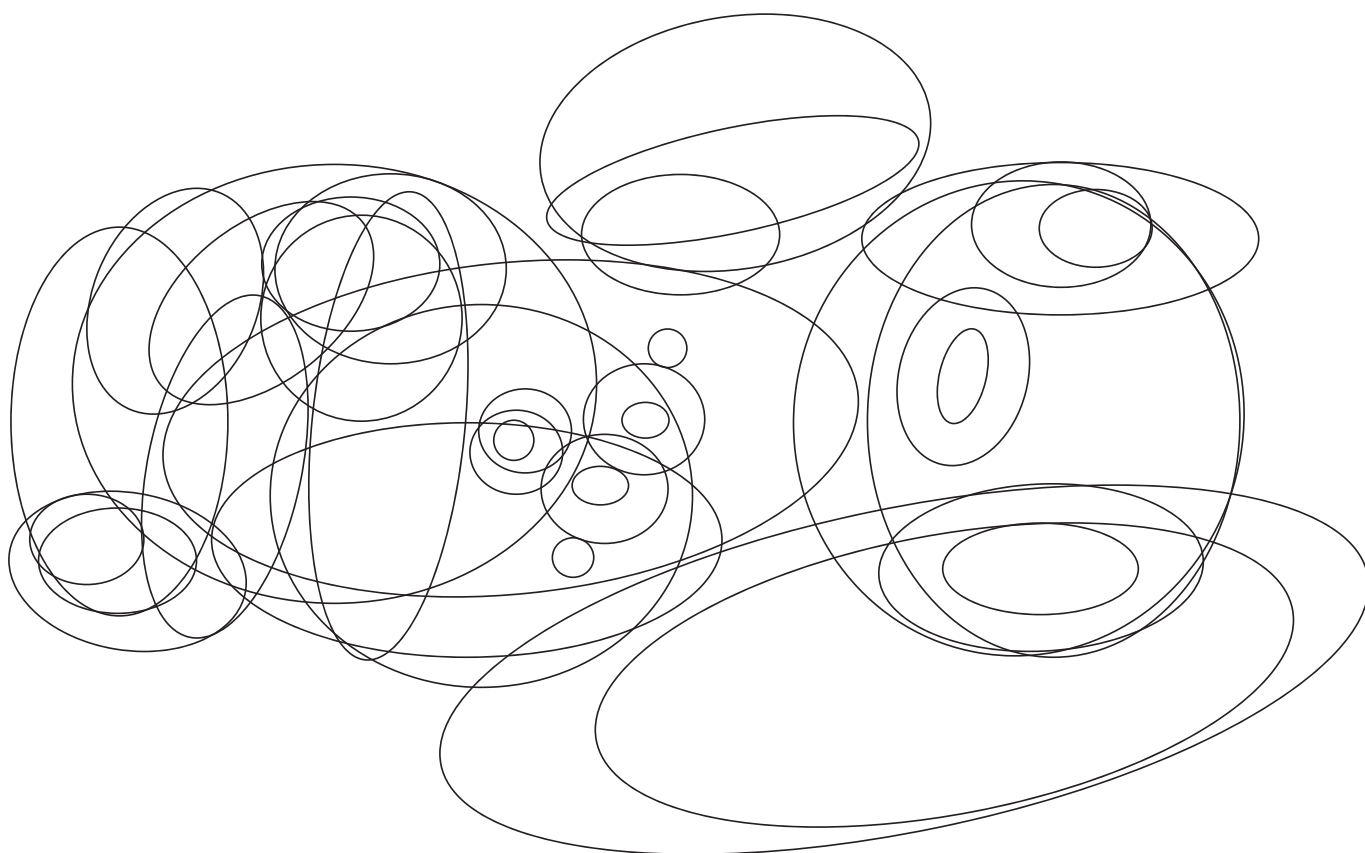
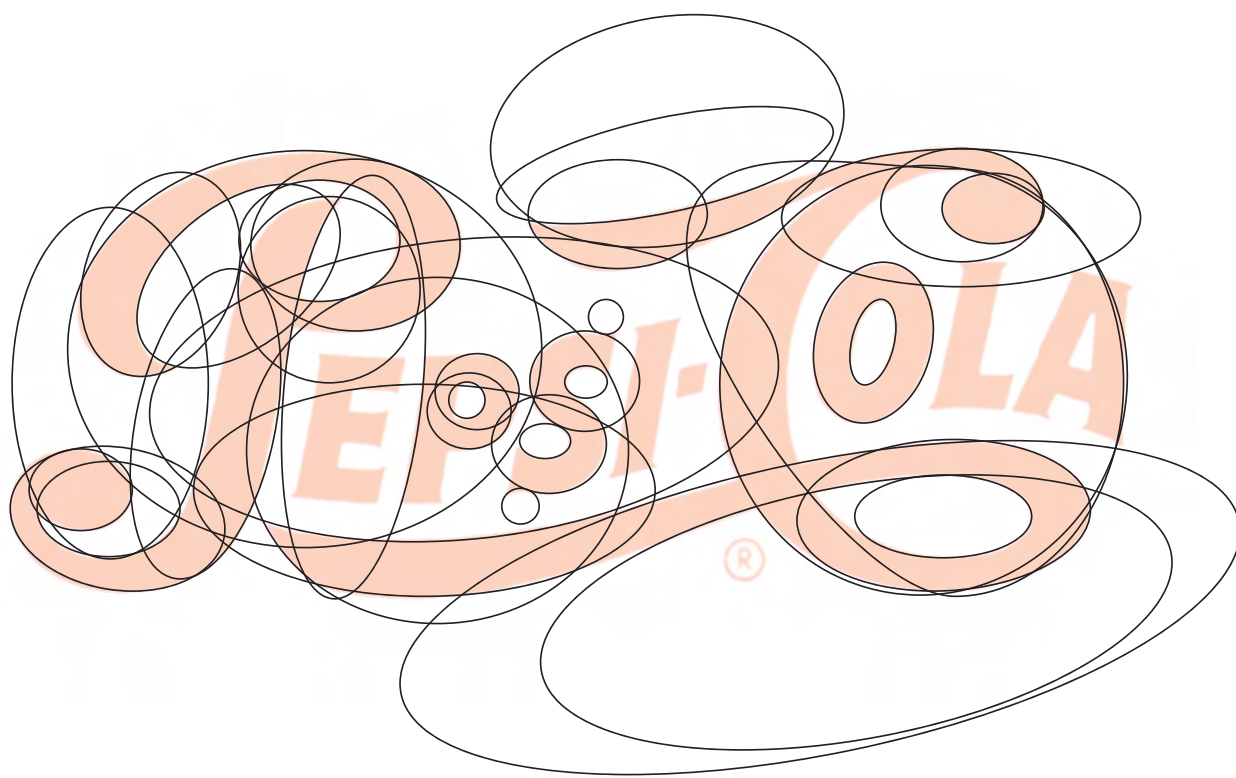

BREATHTAKING

Tracing the Pepsi DNA - 1929

1929 Pepsi Geometries: Perimeter Oscillations

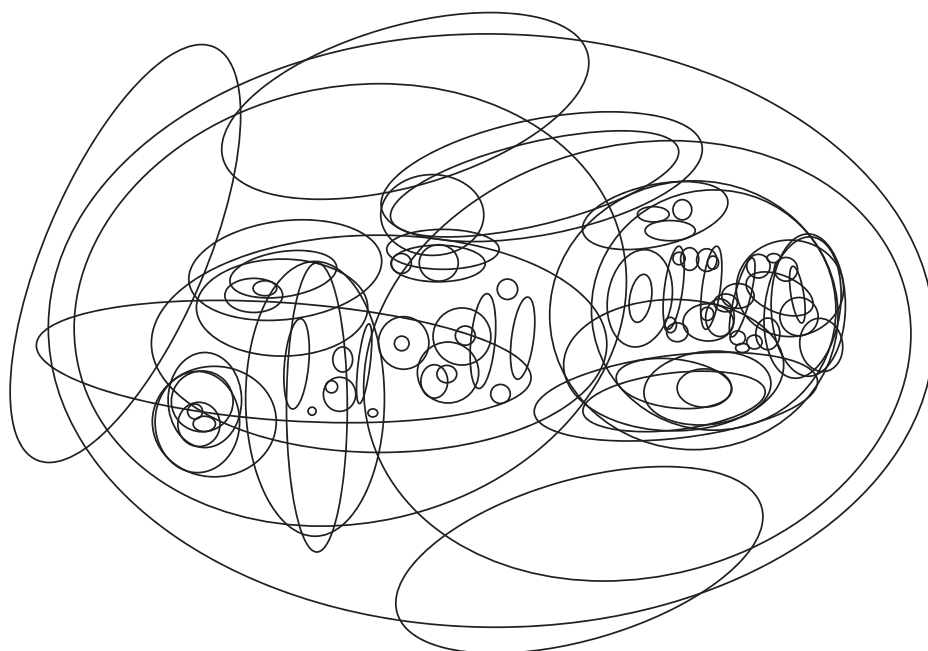
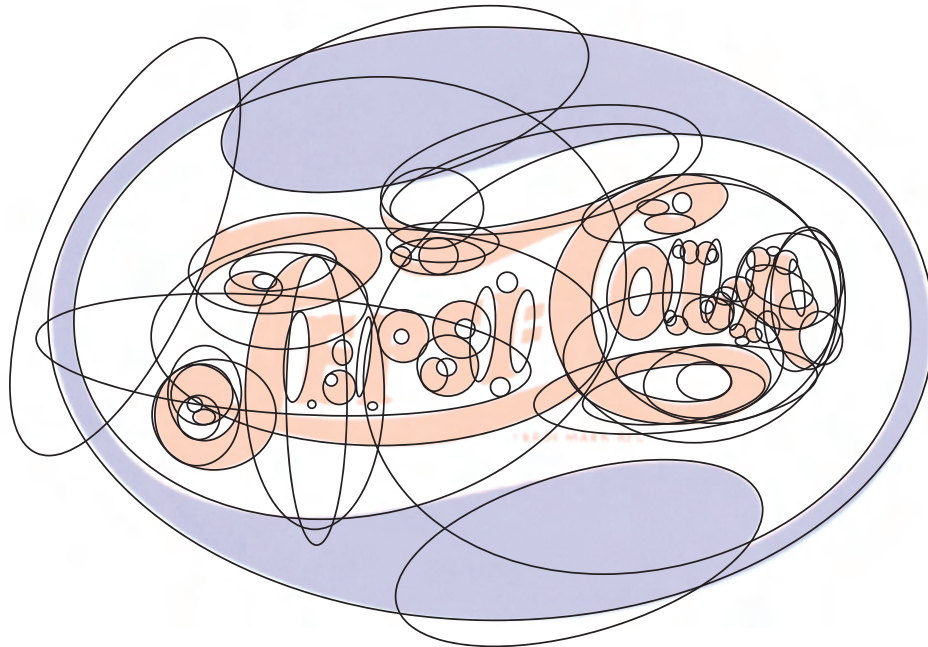

BREATH TAKING

Tracing the Pepsi DNA - 1930

1930 Pepsi Geometries: Perimeter Oscillations

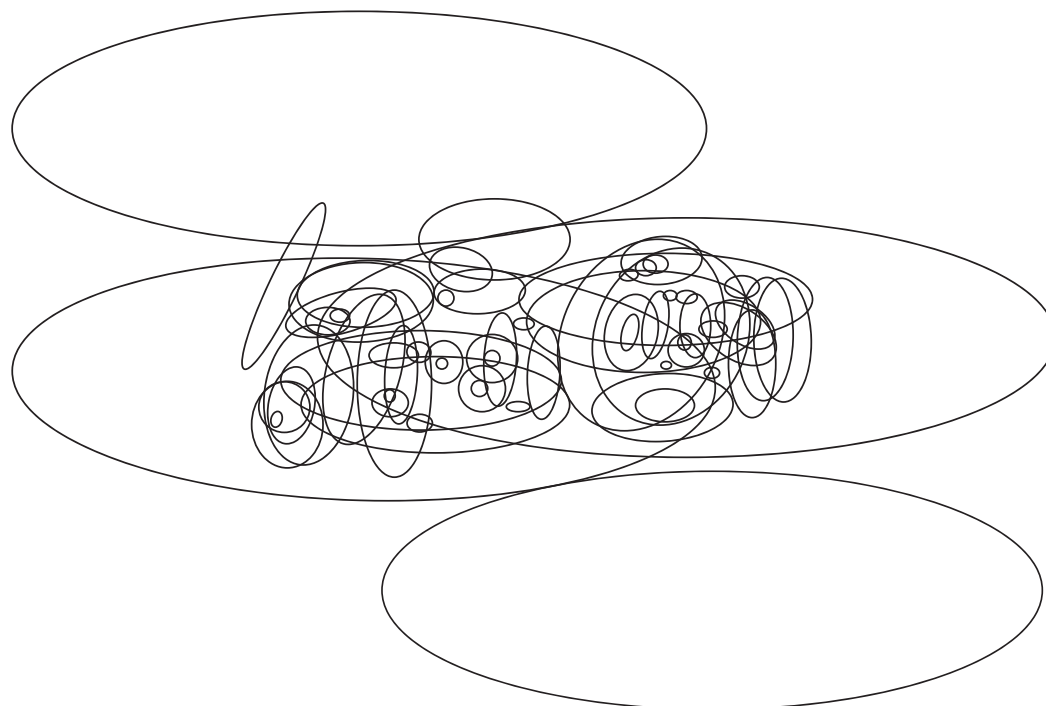
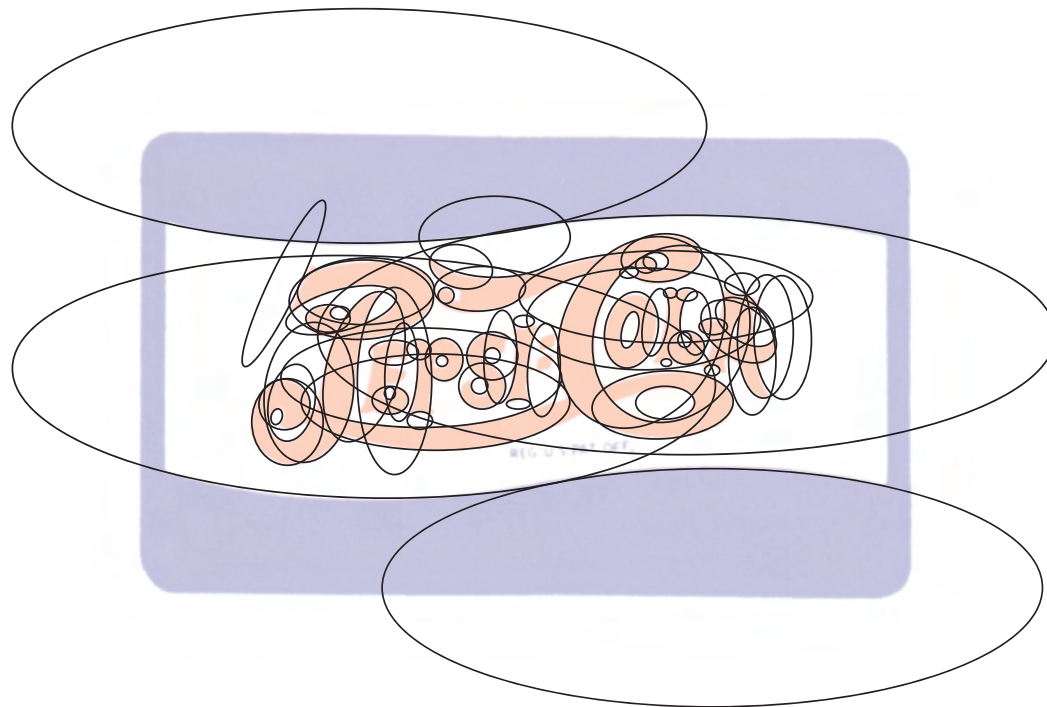

BREATH TAKING

Tracing the Pepsi DNA - 1962

1962 Pepsi Geometries: Perimeter Oscillations

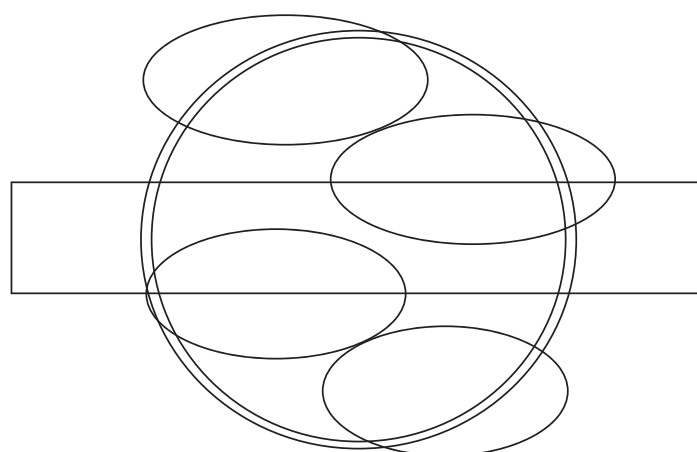
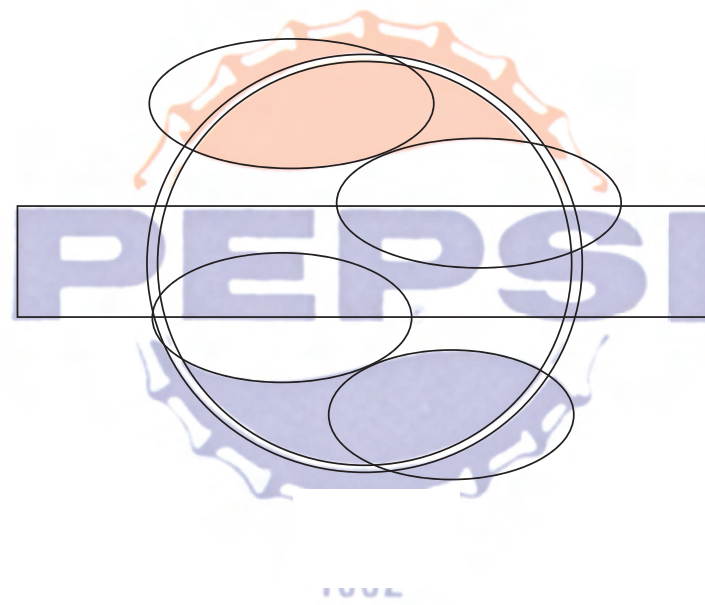

BREATH TAKING

Tracing the Pepsi DNA - 1971

1971 Pepsi Geometries: Perimeter Oscillations

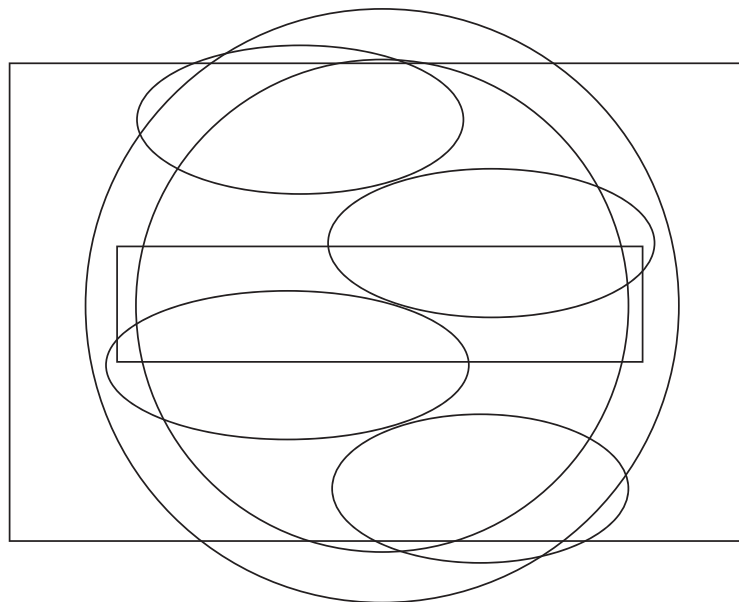
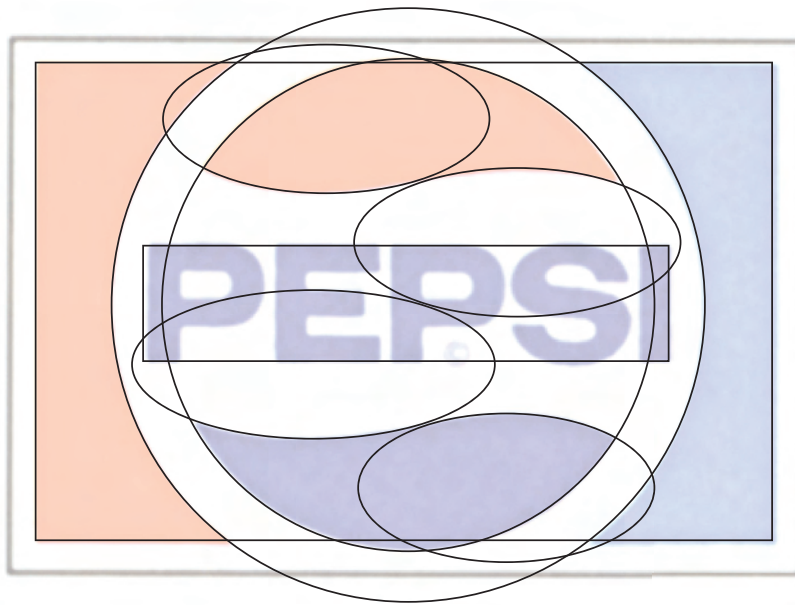

BREATH TAKING

Tracing the Pepsi DNA - 1991

1991 Pepsi Geometries: Perimeter Oscillations

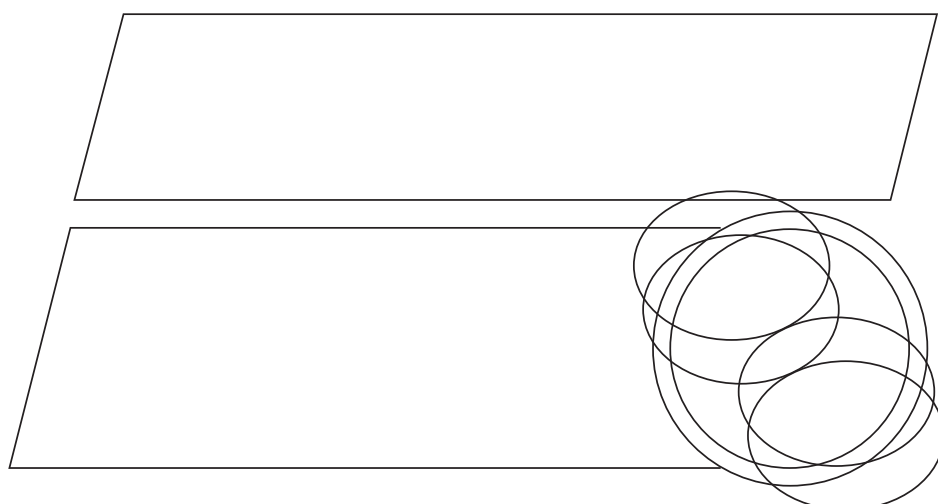

BREATH TAKING

Tracing the Pepsi DNA - 1998

1998 Pepsi Geometries: Perimeter Oscillations

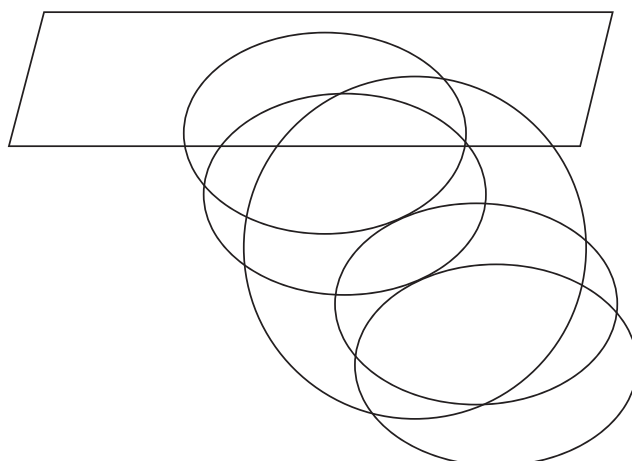
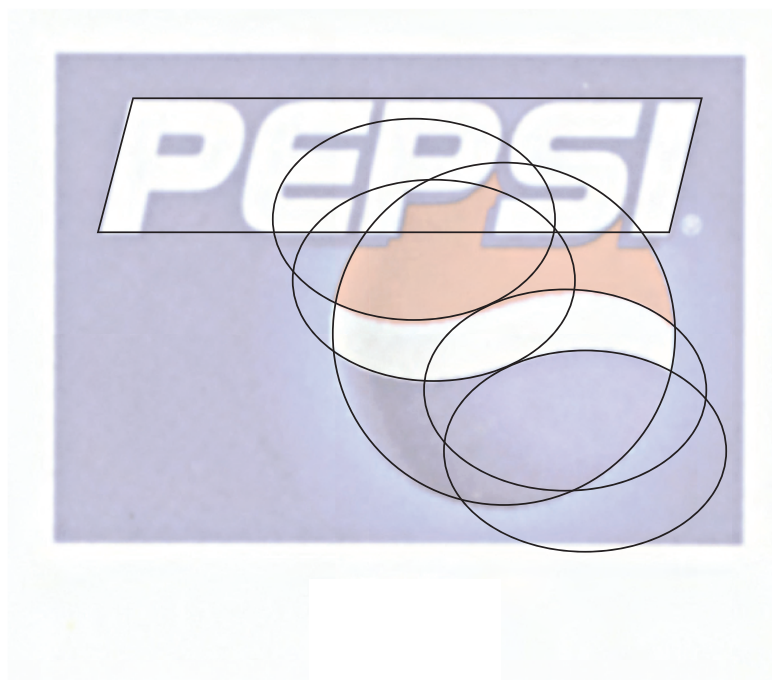

C. TOWARDS INNOVATION: PROJECTING PEPSI'S FUTURE
Applying Universal Laws to Establish a Blueprint for the Brand

BREATHTAKING

Creation of Identity: Precedents

Artists and architects have proportioned their works to approximate the Golden Ratio, especially in the form of the Golden Rectangle, in which the ratio of the longer side to the shorter is the Golden Ratio. They believe this proportion to be universally and aesthetically pleasing. The Golden Ratio plays an essential role in human perception of beauty.

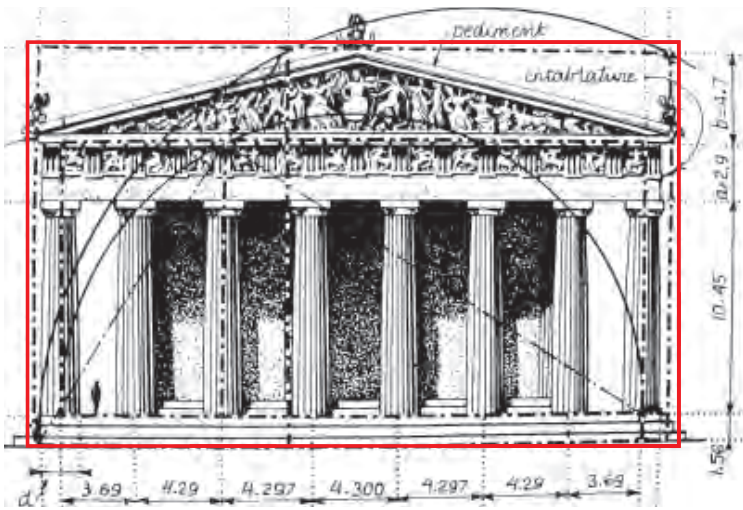

Height and width of the Parthenon is proportioned to yield a Golden Rectangle.

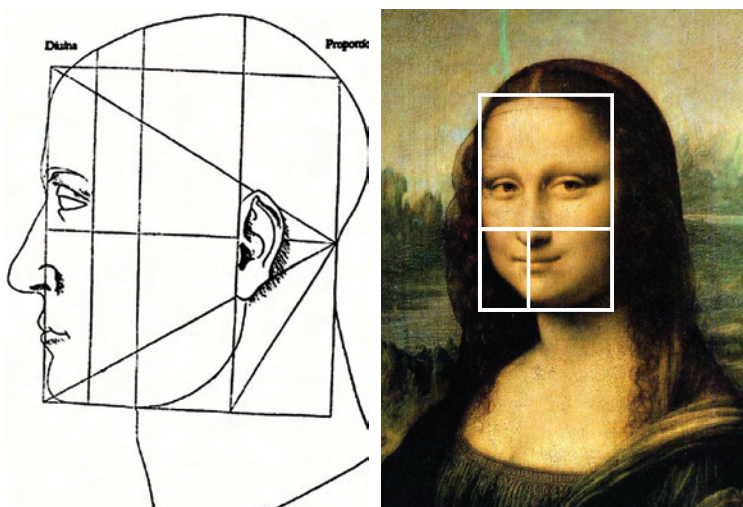

Leonardo Da Vinci studied the proportion of the human face and applied his findings in the Mona Lisa painting.

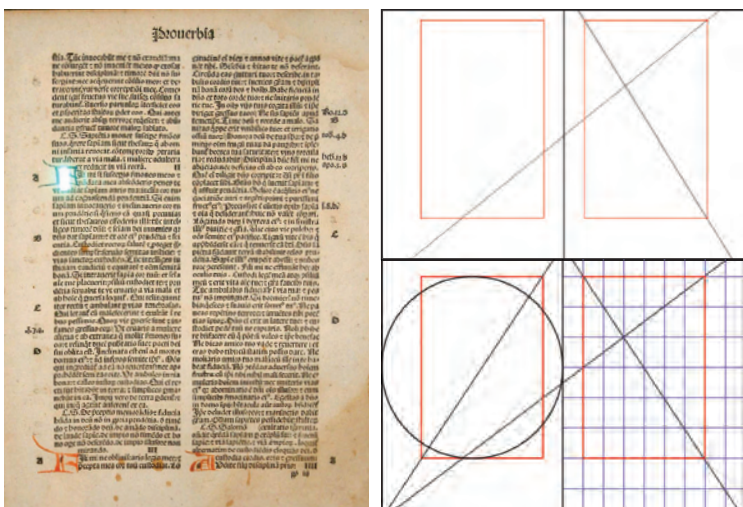

Book format and page layout are based on the Golden Proportion.



The diameter of the Nautilus Shell increases proportionally with the Golden Ratio.

BREATHTAKING

Creation of Identity: A Blueprint for Proportions

A. The Golden Ratio

It starts with a square.

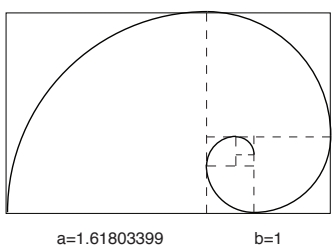
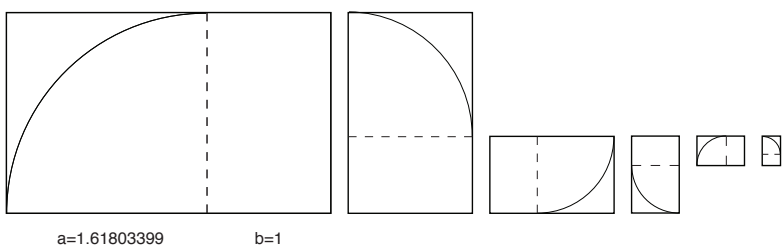
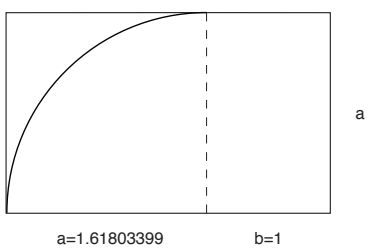
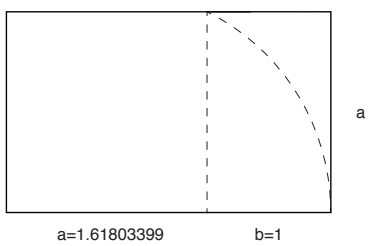
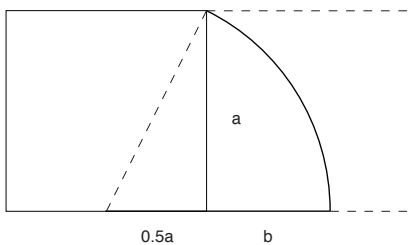
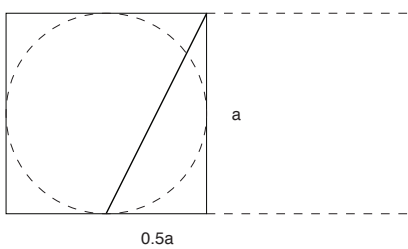
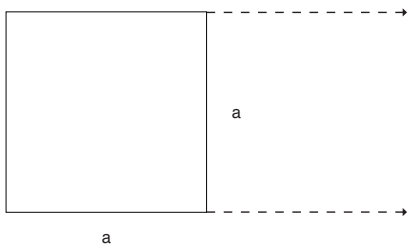
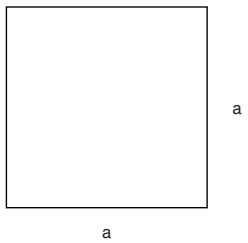

B. The Pepsi Ratio

It starts with a circle.

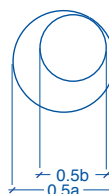
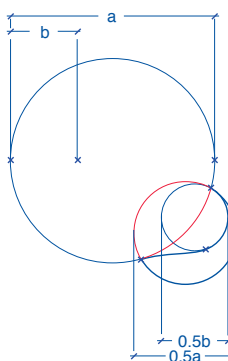
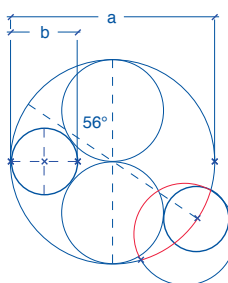
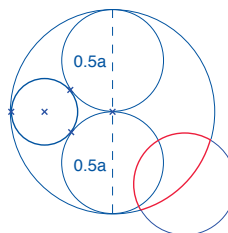
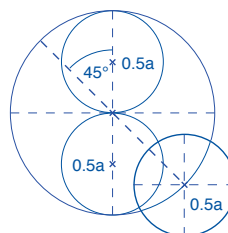
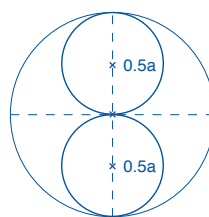
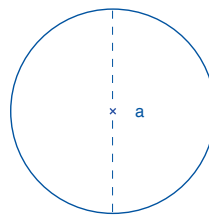

1. Draw a circle with diameter $d=a$.

2. Find its center and draw two same size circles with diameter $d=0.5a$.

3. Rotate the centerline 45° . Copy one of the smaller circles. Place its center on the intersection of the larger circle and the rotated centerline.

4. Draw a circle that lies within the larger one. Its diameter is such that it touches all three circles in exactly and only in one point.

5. Rotate the centerline by 56° . Place the smallest circle with its center on the intersection of the largest circle and the rotated centerline.

6. The Pepsi brand is created by intersecting circles with a set proportion to each other. The coordinates are marked (x).

7. The Pepsi Ratio is created by two simple circles, that are in a set ratio to each other: The Golden Ratio.

8. The Pepsi Ratio is aesthetic geometry.

BREATH TAKING

Creation of Identity: Scales and Dynamic Relationships

A. Geometry of Aesthetics: Proportion

The Golden Ratio establishes a proportion of one part (a) relative to another (b). Playing by these rules produces an aestheticism that is universally accepted to be in balance and harmony. The Pepsi aesthetic respects these rules: The brand identity can be derived from two circles, that have a set relation to each other.

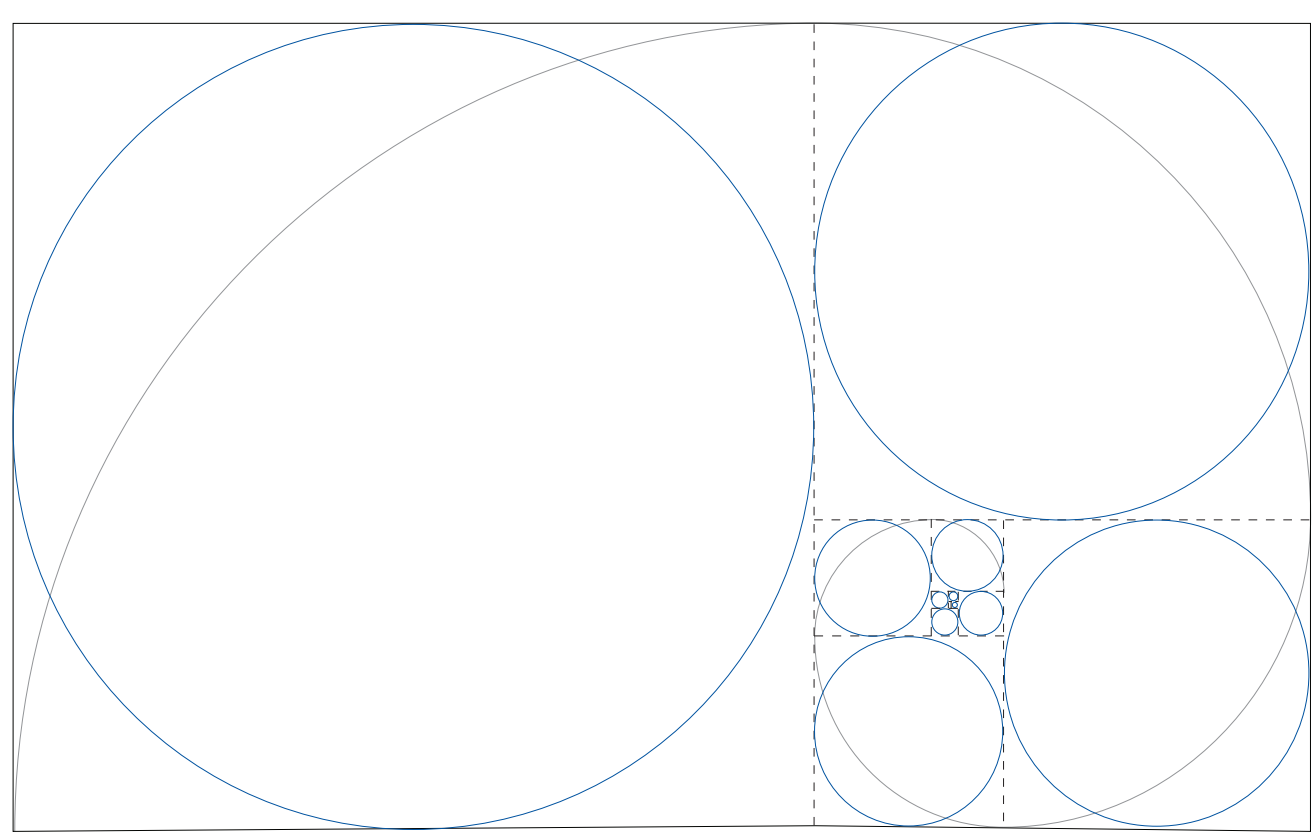
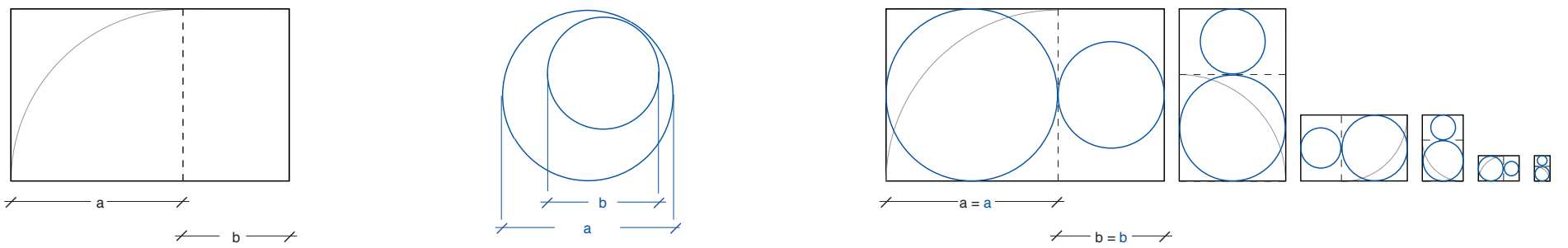

B. Geometry of Aesthetics: Dynamics

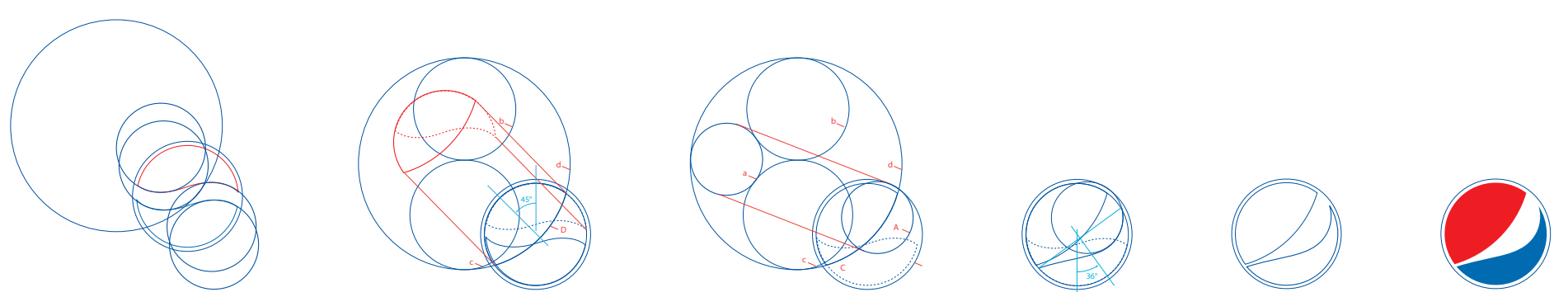

BREATHTAKING

Creation of Identity: Dynamic Forces

A. The Earth's Geodynamo

A naturally occurring electric generator in fluid motion generates and sustains the Earth's magnetic field.

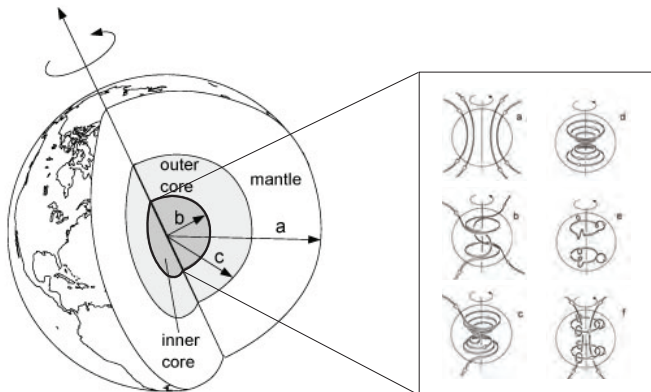

A. The Pepsi Globe

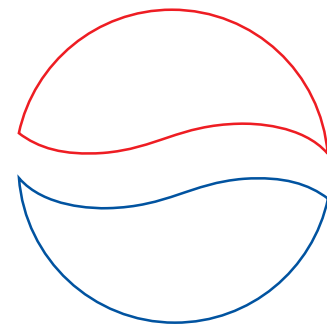

B. Magnetic Fields

Magnetic fields exert forces on inner and outer surfaces of the Earth.

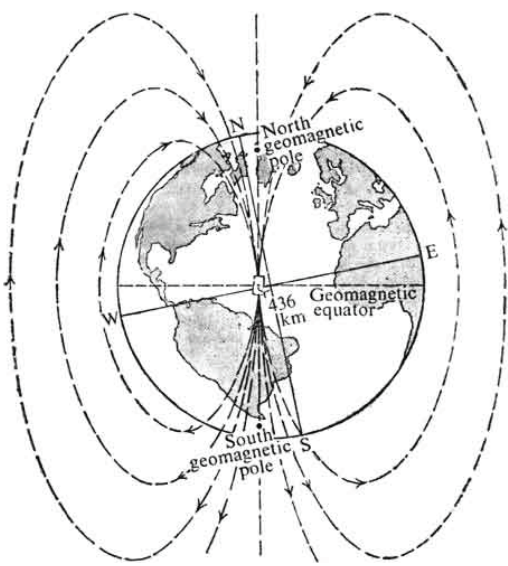

B. Pepsi Energy Fields

Symmetrical energy fields are in balance.

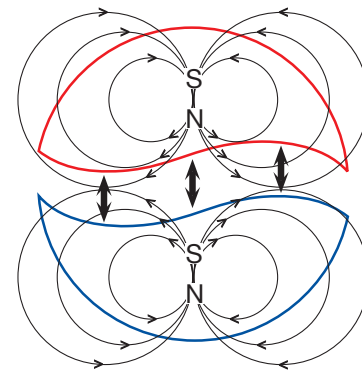

C. Magnetic Dynamics

Magnetic field are impacted by sun radiation and wind motion.

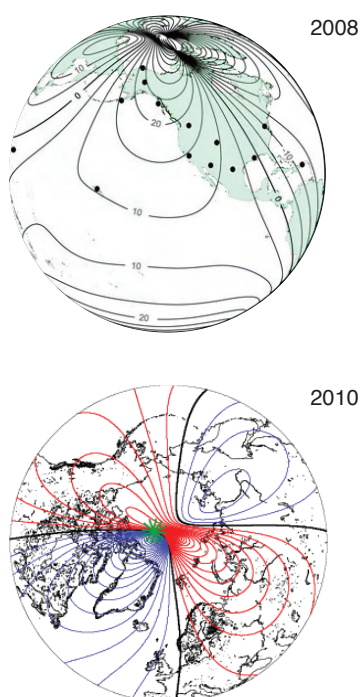

C. The Pepsi Globe Dynamics

Emotive forces shape the gestalt of the brand identity.

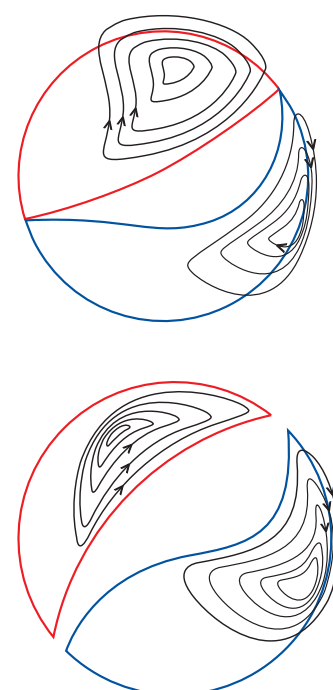

BREATHTAKING

Creation of Identity: Multiple Perspectives

Multiple point of views, One Object

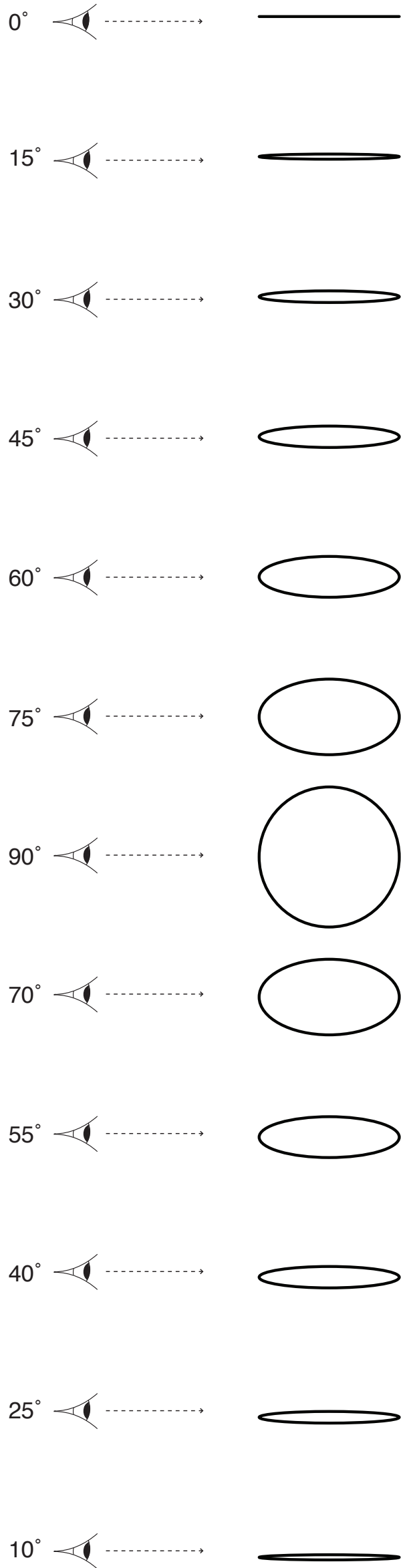

One Identity, Multiple Emotions

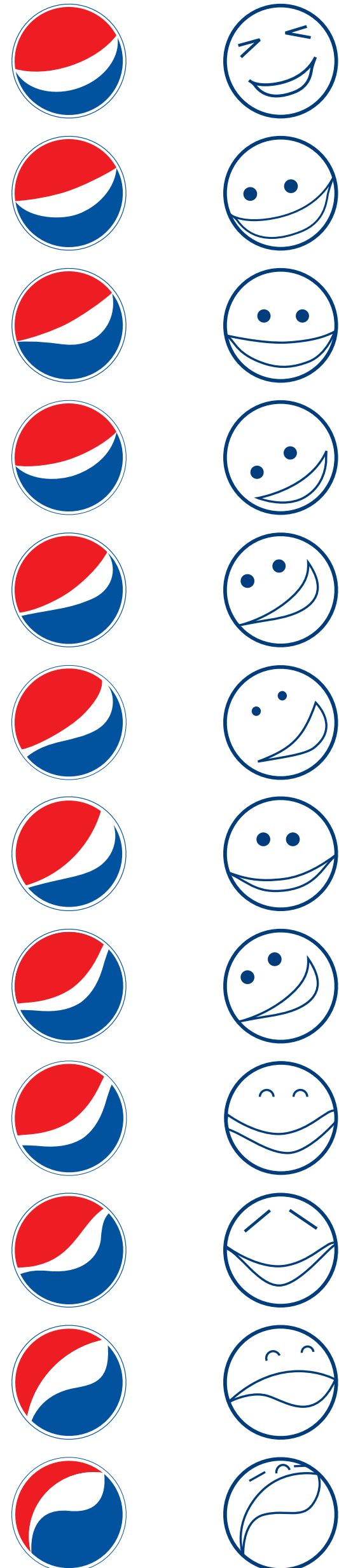

BREATHTAKING

Creation of Identity: The Face of a New Generation

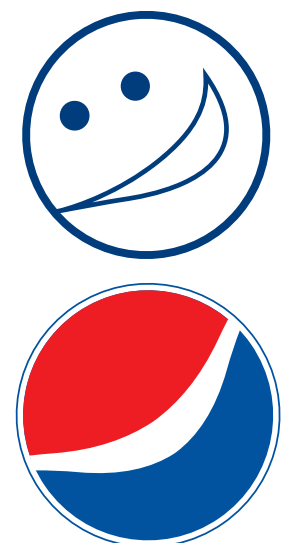
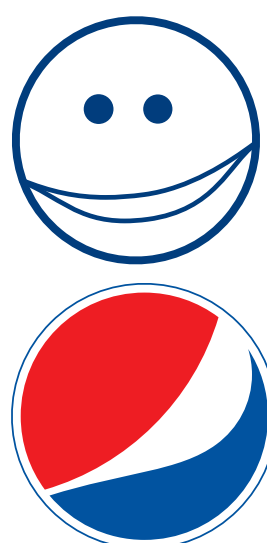
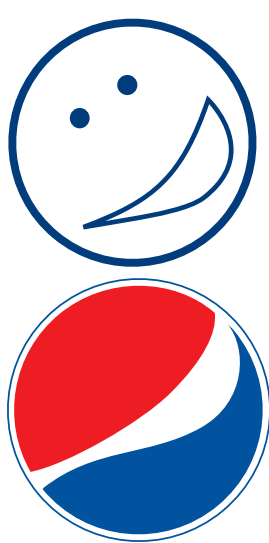
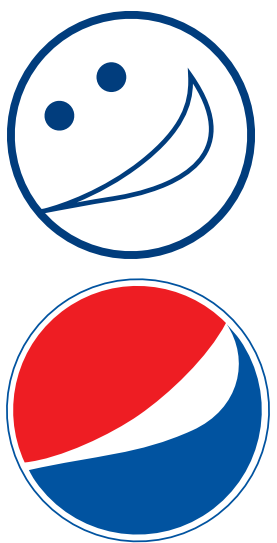
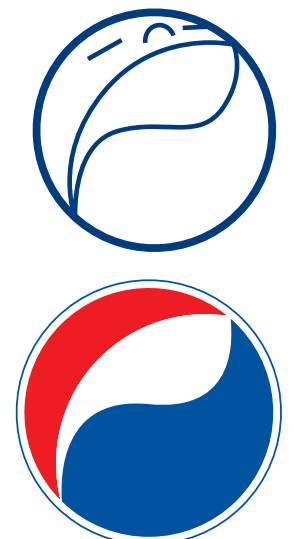
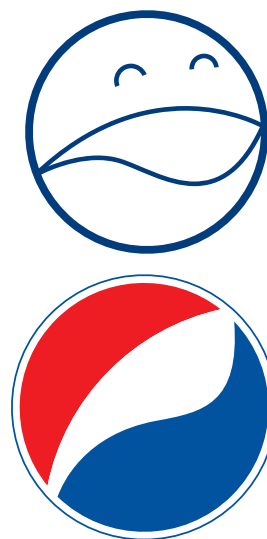
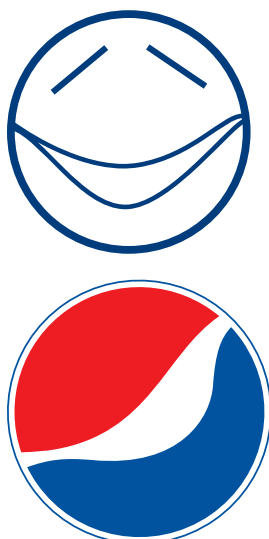
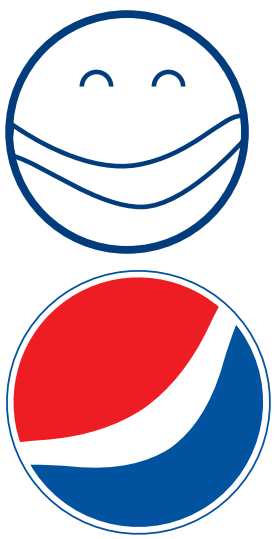
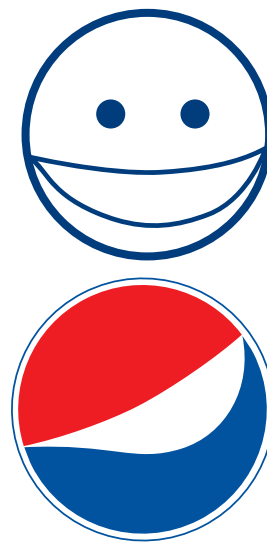
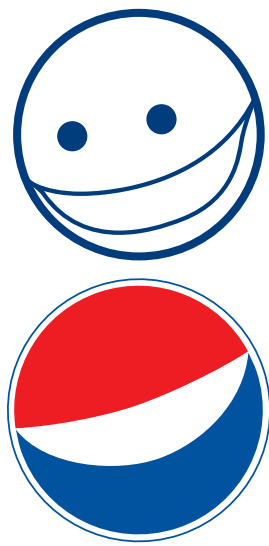

BREATH TAKING

Creation of Identity: A Multi-Dimensionalized Brand

A. Motion Transforms 2D into 3D

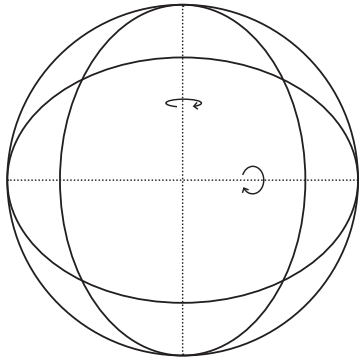

v

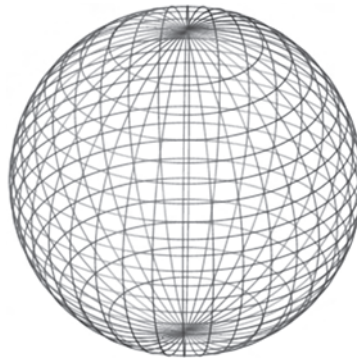

From 2D Circle to 3D Sphere

A sphere is defined as the surface formed by rotating a circle about any diameter.

B. The Brand Identity is Dimensionalized through Motion

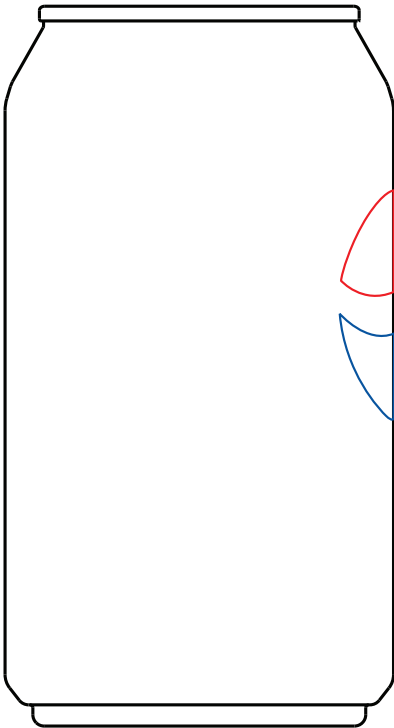

v

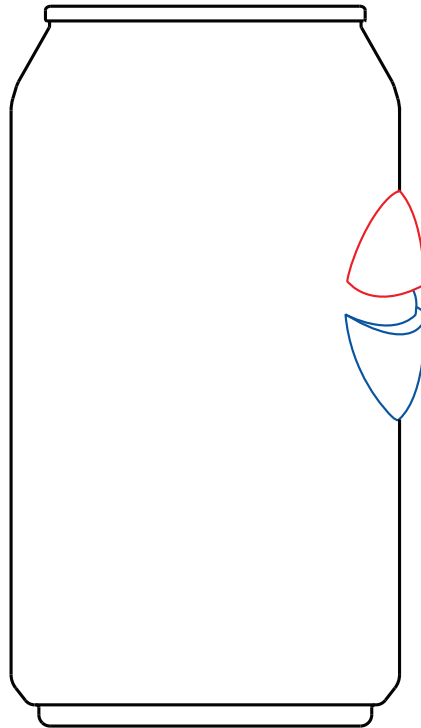

v

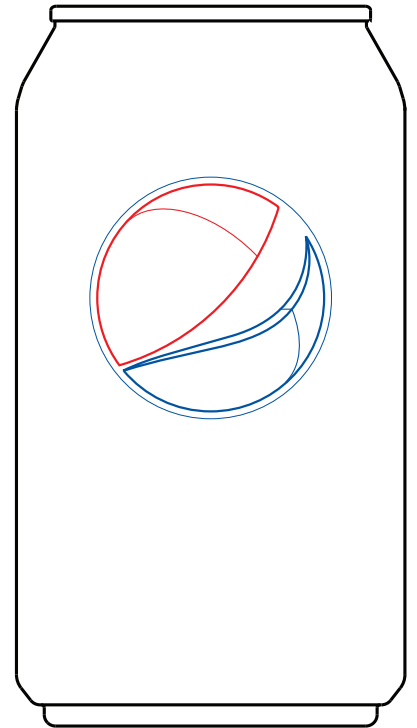

BREATHTAKING

Creation of Identity: Color Theory

A. Objective Color / Subjective Emotion

Each color on the color wheel is associated with a subjective psychic and emotional value.

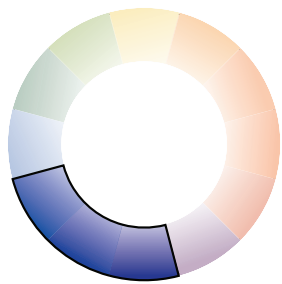

COOL

V



COOL
FRESH

V

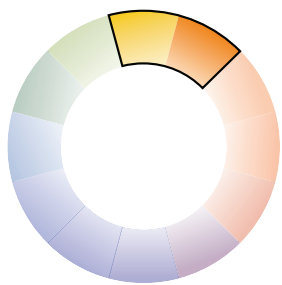

ENERGETIC
BALANCED

V

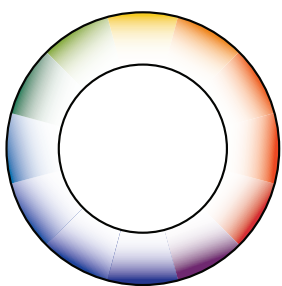

COOL
RICH
FRESH

V

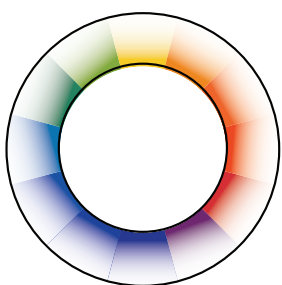

COOL
LIGHT
FRESH

V

B. Breathtaking Color Palette

The Breathtaking Color Palette is derived using a scientific method of color assignment based on the product's essence and primary features.



PEPSI



PEPSI MAX



CAFFEINE FREE PEPSI



DIET PEPSI

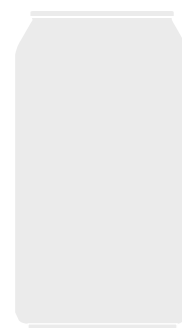

CAFFEINE FREE DIET PEPSI

BREATHTAKING

Creation of Identity: Gravitational Pull

Attraction Theory: The Pepsi Proposition

Establishment of a gravitational pull to shift from a "transactional" experience to an "invitational" expression.

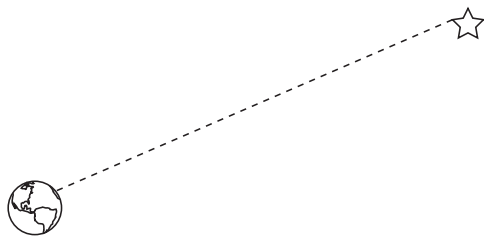

Typical Light Path

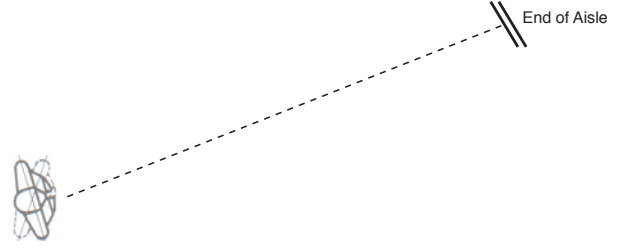

Typical Shopping Aisle

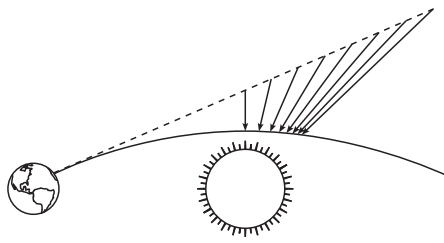

Light Path with Gravitational Pull

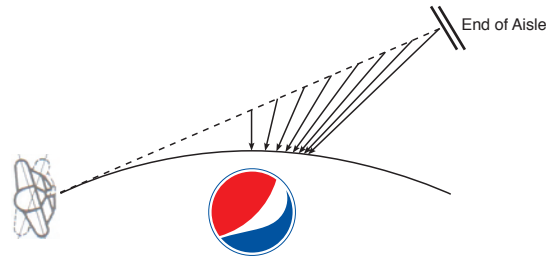

Gravitational Pull of Pepsi

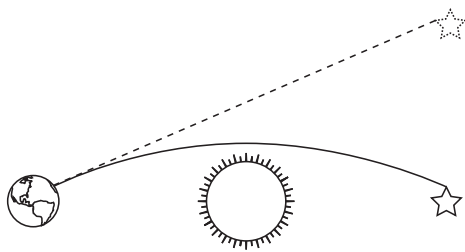

Relativity of Space and Time

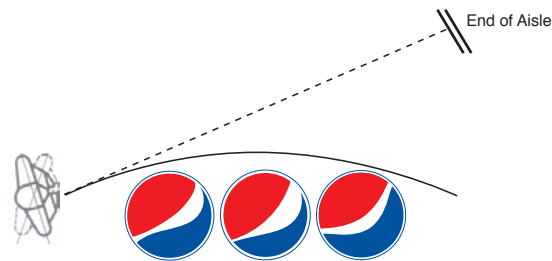

Pepsi Proposition / Pepsi Aisle

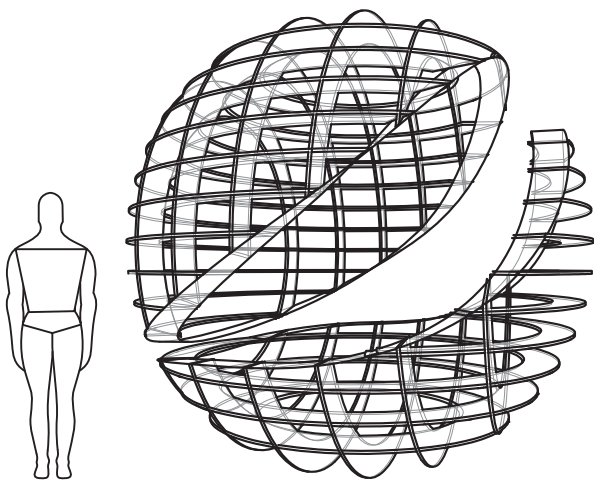

Pepsi Aisle 60°

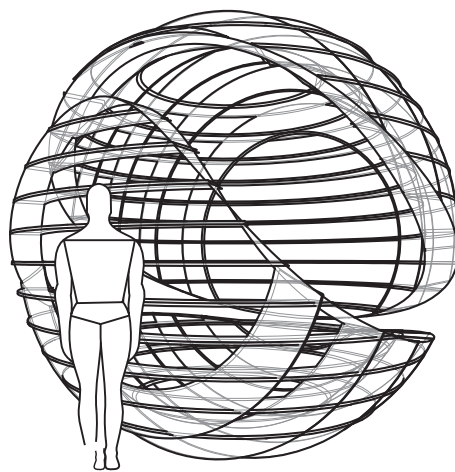

Pepsi Aisle 30°



Pepsi Aisle 10°

BREATHTAKING

Creation of Identity: The Pepsi Universe

A. Universe Expansion

The universe expands exponentially with $f(x)=e^x$.
[1 light year = 671 million miles per hour].

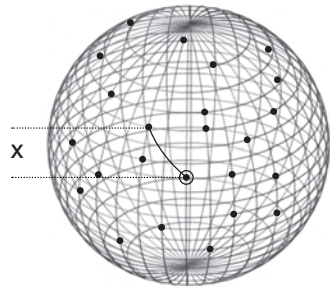

x=1 light year

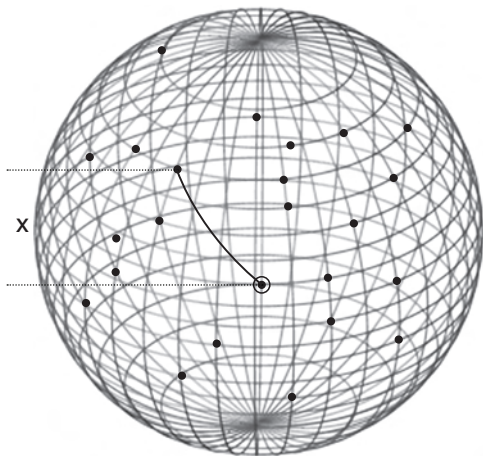

x=2 light year

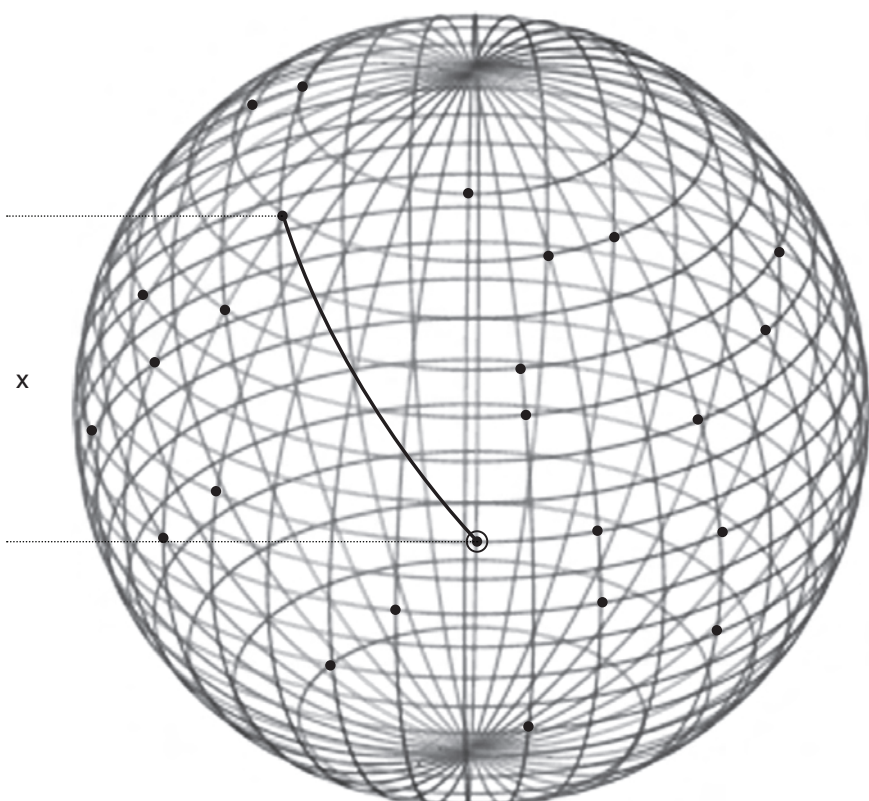

x=8 light year

B. The Pepsi Orbits

Dimensionalize exponentially.

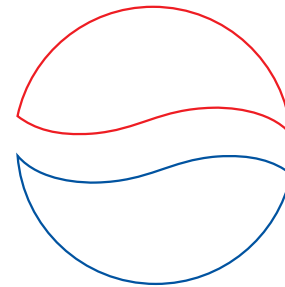

Pepsi Planet

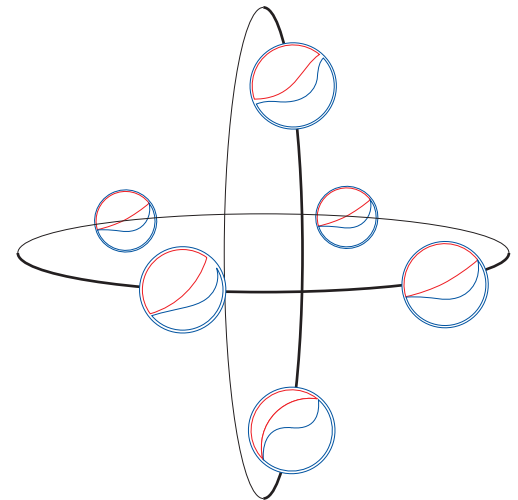

Pepsi Galaxy

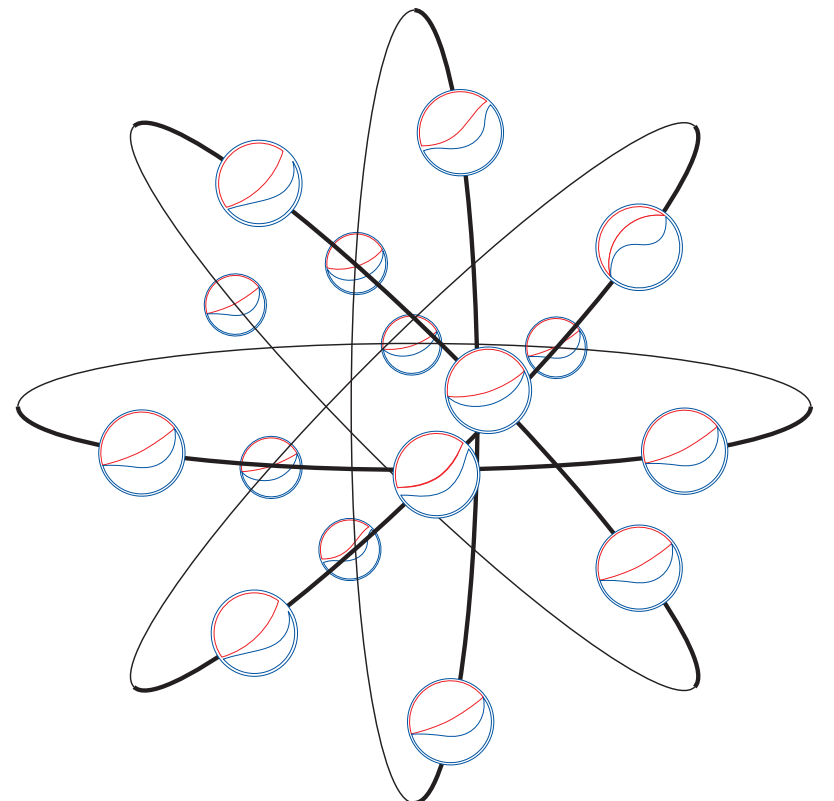

Pepsi Universe